

H — FAMILY HINGES

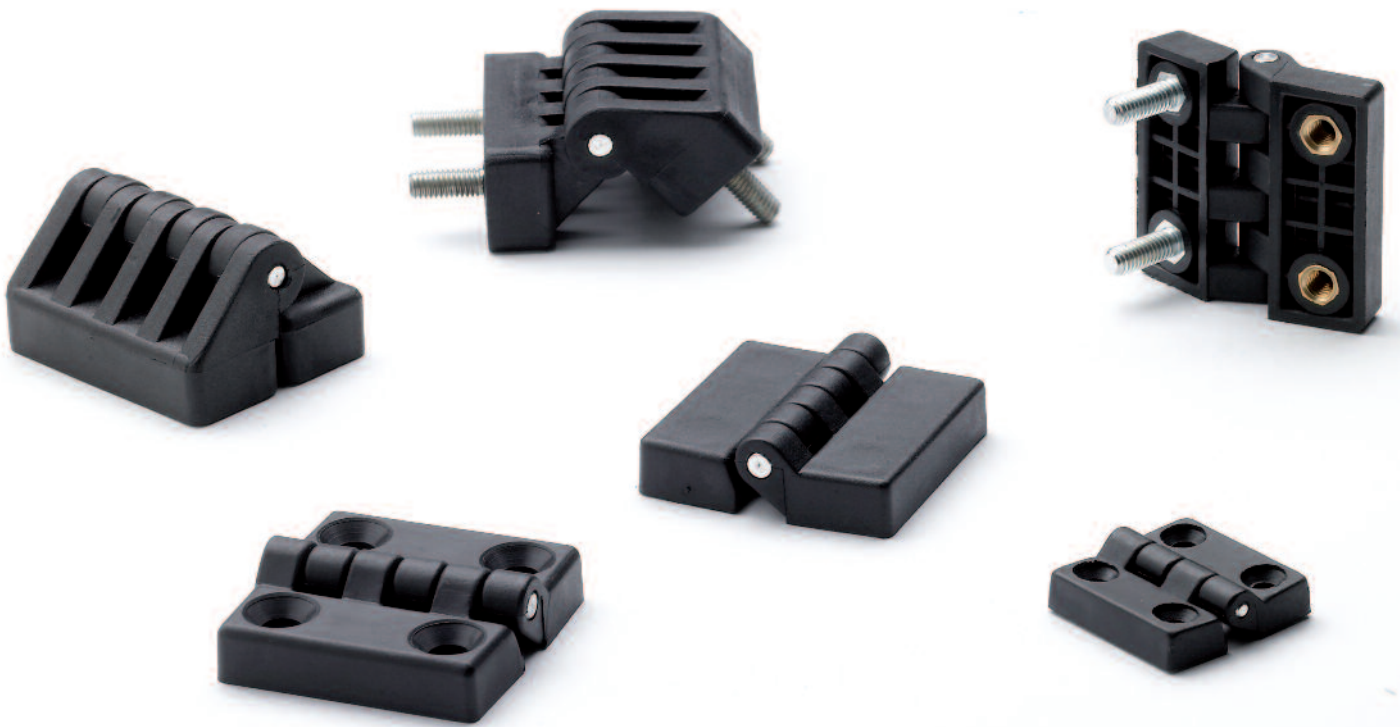

 **ROLLMEX**

ART. 0400

HINGE WITH THROUGH HOLES

MATERIAL:

Reinforced polyamide.
Oils and greases resistant.

SURFACE:

Satin.

COLOUR:

Black (RAL 9011).

MAIN INSERT:

Zinc plated steel pin.

HOLE:

Through hole obtained by moulding the plastic.
Seat for countersunk screws DIN 7991 / UNI 5933.



SPECIAL REQUESTS:

- It is possible to supply colours as shown in the table at page 15, on request and for quantities.

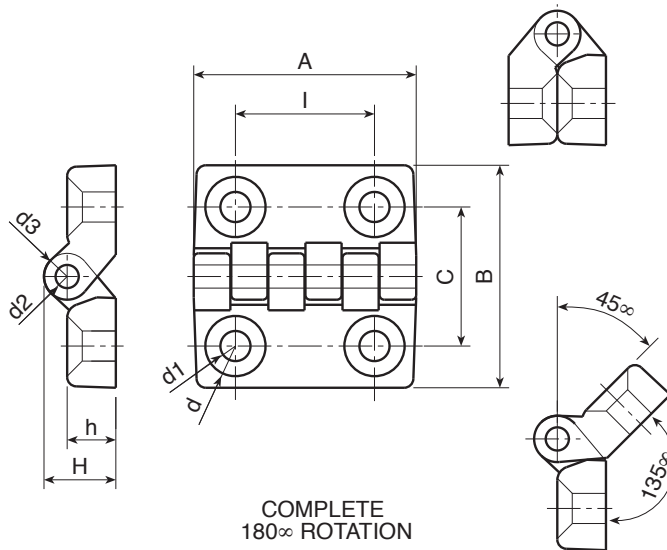
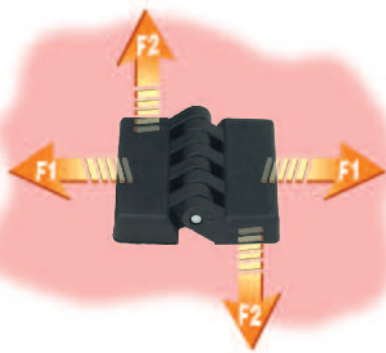

Art.	I	C	A	B	h	H	d1	d	d2	d3	Weight (gr)	F1 (N)	F2 (N)
O400-20 M4	20	20	32	32	7	10,5	4,5	8	3	7	9	1440	490
O400-30 M6	30	30	48	48	10,5	15,5	6,5	13	5	10	27	1960	1470
O400-40 M6	40	40	64	64	13	19	6,5	13	5	12	53	2850	1520
O400-60 M8	60	63	96	96	16	24	8,5	16	8	16	152	4300	1810
O400-60 M10	60	63	96	96	16	24	10,5	20	8	16	152	4300	1810

ART. 0401

HINGE WITH THROUGH HOLES AND STAINLESS STEEL PIN

INOX

MATERIAL:

Reinforced polyamide.
Oils and greases resistant.

SURFACE:

Satin.

COLOUR:

Black (RAL 9011).

MAIN INSERT:

Stainless steel pin (AISI 303).

HOLE:

Through hole obtained by moulding the plastic.
Seat for countersunk screws DIN 7991 / UNI 5933.

SPECIAL REQUESTS:

- It is possible to supply colours as shown in the table at page 15, on request and for quantities.

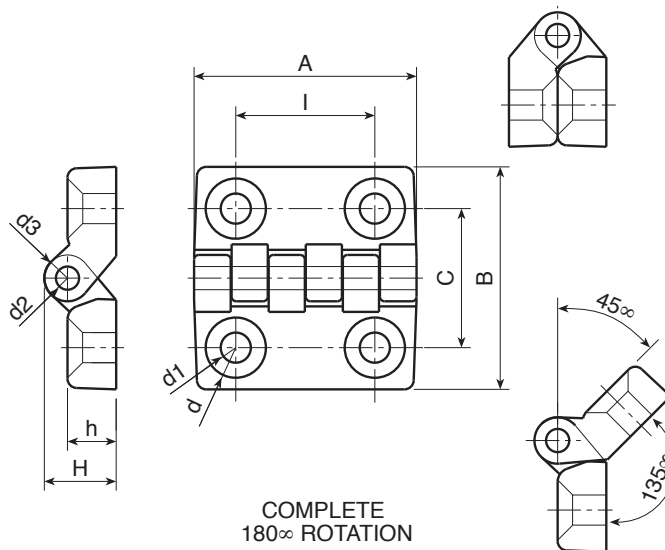
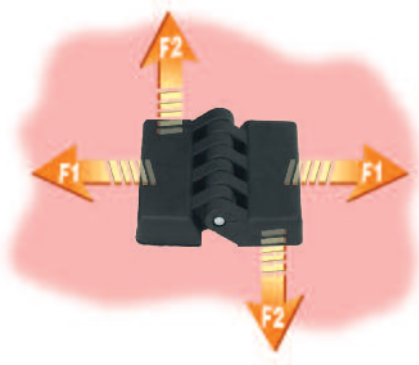

Art.	I	C	A	B	h	H	d1	d	d2	d3	Weight (gr)	F1 (N)	F2 (N)
O401-20 M4	20	20	32	32	7	10,5	4,5	8	3	7	9	1440	490
O401-30 M6	30	30	48	48	10,5	15,5	6,5	13	5	10	27	1960	1470
O401-40 M6	40	40	64	64	13	19	6,5	13	5	12	53	2850	1520
O401-60 M8	60	63	96	96	16	24	8,5	16	8	16	152	4300	1810
O401-60 M10	60	63	96	96	16	24	10,5	20	8	16	152	4300	1810

ART. 0430

FLAT HINGE WITH THREADED INSERT

MATERIAL:

Reinforced polyamide.
Oils and greases resistant.

SURFACE:

Satin.

COLOUR:

Black (RAL 9011).

INSERTS:

Zinc plated steel pin.
Brass blind threaded bush.

SPECIAL REQUESTS:

- It is possible to supply the inserts in different materials, on request and for quantities.
- It is possible to supply colours as shown in the table at page 15, on request and for quantities.

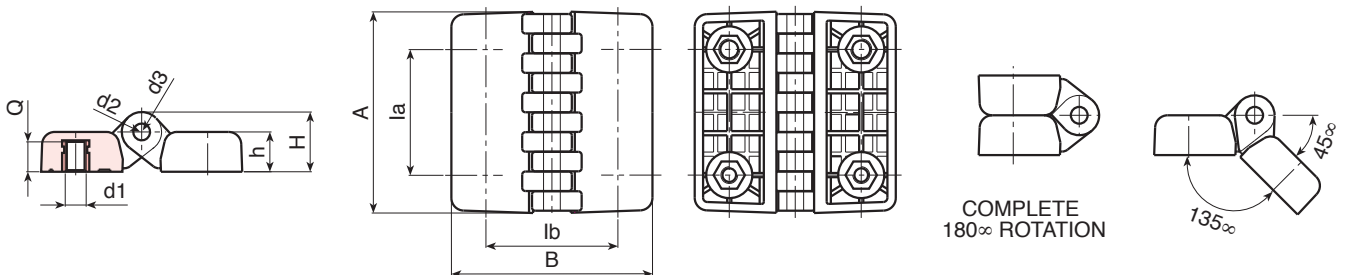
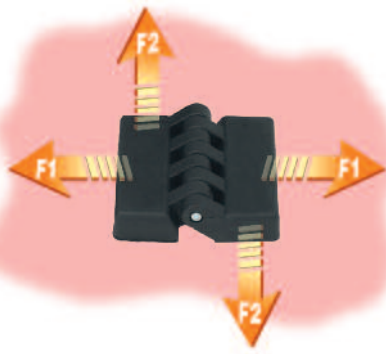

Art.	la	lb	A	B	h	H	d1	Q	d2	d3	Weight (gr)	F1 (N)	F2 (N)
O430-30 M5	30	30	48	48	10,5	15,5	M5	7	5	10	35	2000	1370
O430-30 M6	30	30	48	48	10,5	15,5	M6	7	5	10	35	2000	1370
O430-40 M6	40	40	64	64	13	19	M6	9	5	12	67	4100	1800
O430-40 M8	40	40	64	64	13	19	M8	9	5	12	65	4100	1800
O430-60 M8	60	63	95	95	19	28,5	M8	13	8	18	226	2450	2650
O430-60 M10	60	63	95	95	19	28,5	M10	13	8	18	228	2450	2650

ART. 0431

FLAT HINGE WITH THREADED STUD

MATERIAL:

Reinforced polyamide.
Oils and greases resistant.

SURFACE:

Satin.

COLOUR:

Black (RAL 9011).

INSERTS:

Zinc plated steel pin.
Zinc plated steel threaded stud.

SPECIAL REQUESTS:

- It is possible to supply the inserts in different materials, on request and for quantities.
- It is possible to supply colours as shown in the table at page 15, on request and for quantities.

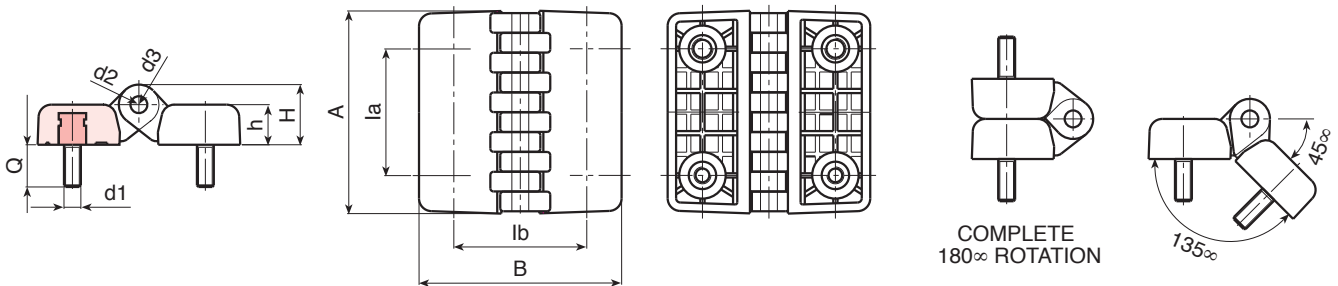
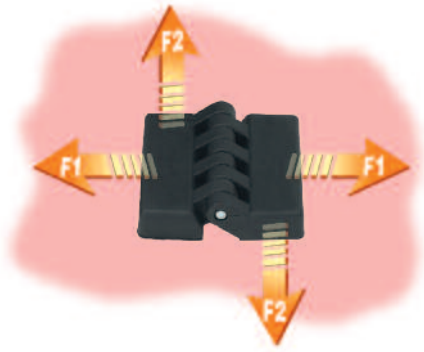

Art.	la	lb	A	B	h	H	d1	Q	d2	d3	Weight (gr)	F1 (N)	F2 (N)
O431-30 M5	30	30	48	48	10,5	15,5	M5	15	5	10	49	1780	1370
O431-30 M6	30	30	48	48	10,5	15,5	M6	15	5	10	52	1780	1370
O431-40 M6	40	40	64	64	13	19	M6	20	5	12	90	4120	1760
O431-40 M8	40	40	64	64	13	19	M8	20	5	12	100	4120	1760
O431-60 M8	60	63	95	95	19	28,5	M8	20	8	18	260	4900	1275
O431-60 M10	60	63	95	95	19	28,5	M10	20	8	18	278	4900	1275

FLAT HINGE WITH THREADED STUD AND THREADED INSERT

MATERIAL:

Reinforced polyamide.
Oils and greases resistant.

SURFACE:

Satin.

COLOUR:

Black (RAL 9011).

INSERTS:

Zinc plated steel pin.
Brass blind threaded bush.
Zinc plated steel threaded stud.

SPECIAL REQUESTS:

- It is possible to supply colours as shown in the table at page 15, on request and for quantities.

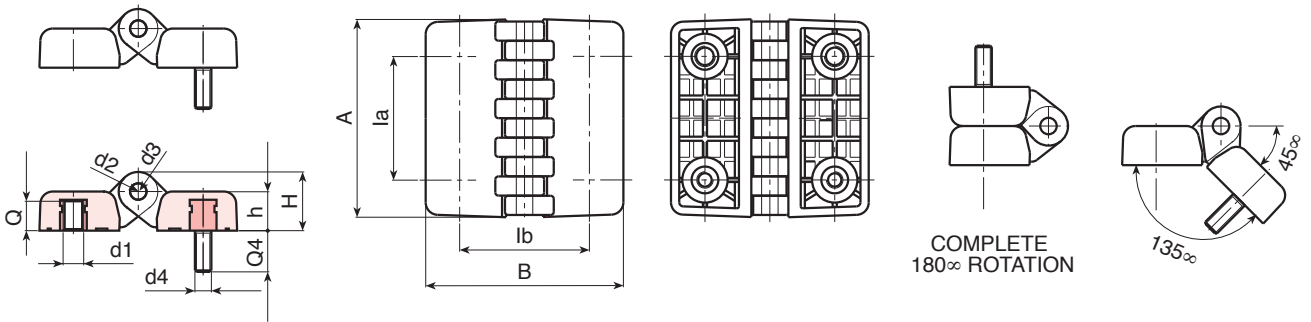
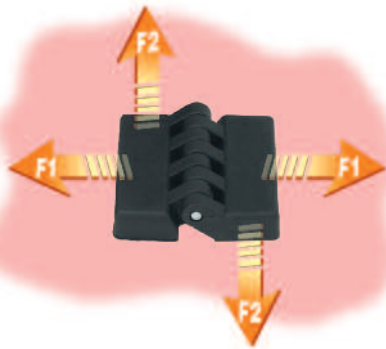

Art.	la	lb	A	B	h	H	d1	Q	d4	Q4	d2	d3	Weight (gr)	F1 (N)	F2 (N)
O432-30 M5	30	30	48	48	10,5	15,5	M5	7	M5	15	5	10	40	1850	1350
O432-30 M6	30	30	48	48	10,5	15,5	M6	7	M6	15	5	10	41	1850	1350
O432-40 M6	40	40	64	64	13	19	M6	9	M6	20	5	12	73	4000	1600
O432-40 M8	40	40	64	64	13	19	M8	9	M8	20	5	12	85	4000	1600
O432-60 M8	60	63	95	95	19	28,5	M8	13	M8	20	8	18	240	3100	1400
O432-60 M10	60	63	95	95	19	28,5	M10	13	M10	20	8	18	250	3100	1400

FLAT HINGE WITH THREADED INSERT AND THROUGH HOLES

MATERIAL:

Reinforced polyamide.
Oils and greases resistant.

SURFACE:

Satin.

COLOUR:

Black (RAL 9011).

INSERTS:

Zinc plated steel pin.
Brass blind threaded bush.

HOLE:

Through hole obtained by moulding the plastic.
Seat for countersunk screws DIN 7991/UNI 5933.



SPECIAL REQUESTS:

- It is possible to supply the inserts in different materials, on request and for quantities.
- It is possible to supply colours as shown in the table at page 15, on request and for quantities.

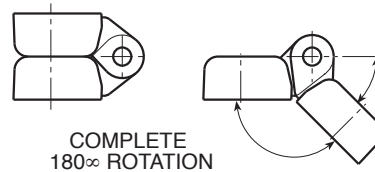
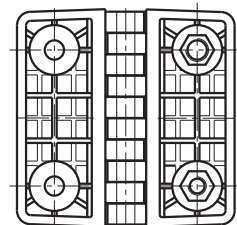
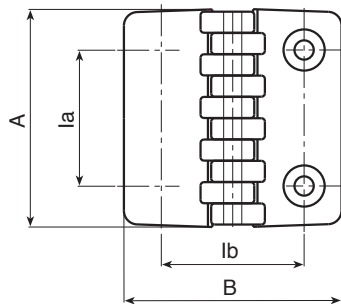
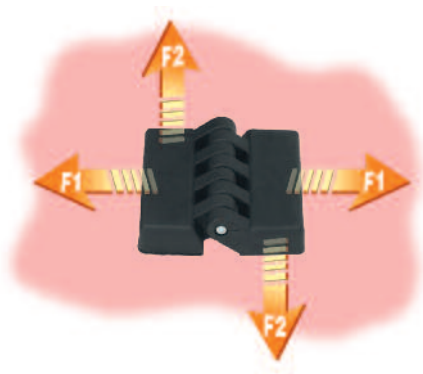
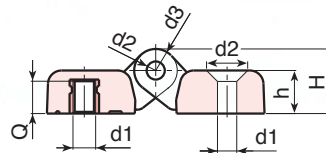

Art.	la	lb	A	B	h	H	d1	Q	d2	d3	Weight (gr)	F1 (N)	F2 (N)
O433-30 M6	30	30	48	48	10,5	15,5	M6 / D6,5	7	5	10	31	2000	1400
O433-40 M6	40	40	64	64	13	19	M6 / D6,5	9	5	12	60	3500	1650

ART. 0410

SHIM FOR 0400-30 HINGE WITH THROUGH HOLES

MATERIAL:

Reinforced polyamide.
Oils and greases resistant.

SURFACE:

Satin.

COLOUR:

Black (RAL 9011).

SPECIAL REQUESTS:

- None.

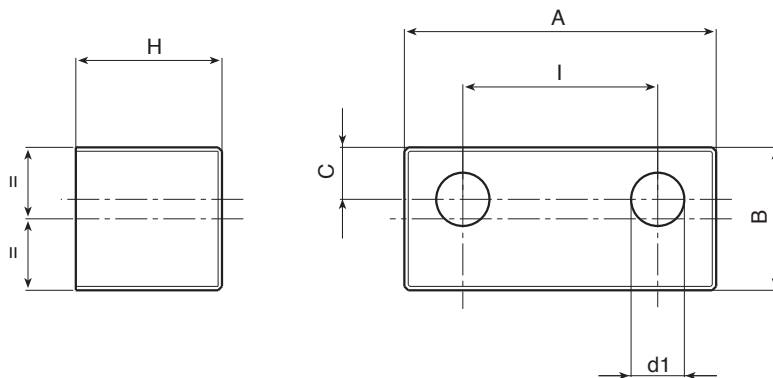
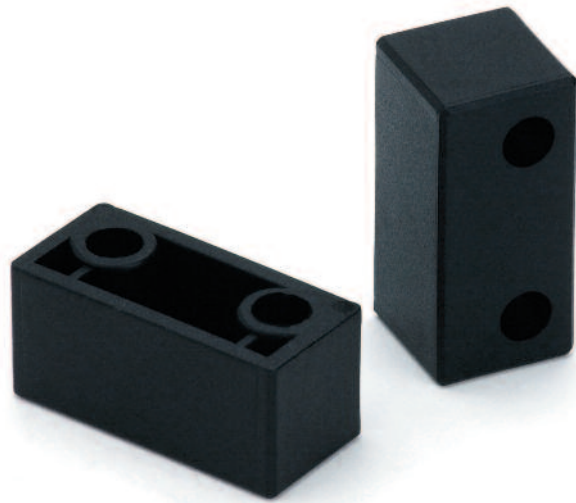

Art.	I	C	A	B	H	d1	Weight (gr)
0410-30	30	8	48	22	22,5	8,5	19

ART. 0411

SHIM FOR 0400-40 HINGE WITH THROUGH HOLES

MATERIAL:

Reinforced polyamide.
Oils and greases resistant.

SURFACE:

Satin.

COLOUR:

Black (RAL 9011).

SPECIAL REQUESTS:

- None.

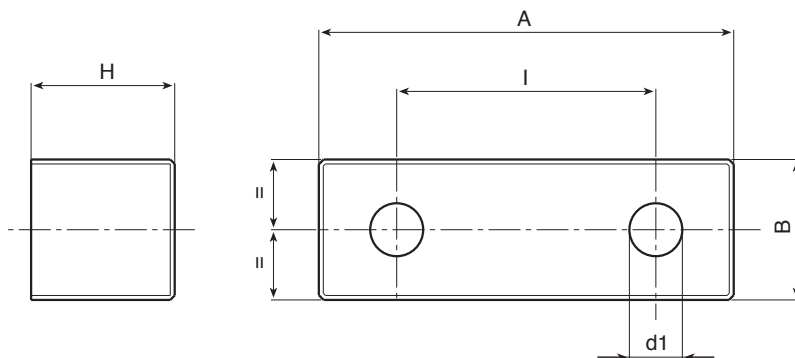

Art.	I	A	B	H	d1	Weight (gr)
0411-40	40	65	22	22,5	8,5	24

ART. 0450

UNIVERSAL HINGE WITH THREADED INSERT FOR MOUNTING ON STRAIGHT DOOR

MATERIAL:

Reinforced polyamide.
Oils and greases resistant.

SURFACE:

Satin.

COLOUR:

Black (RAL 9011).

INSERTS:

Zinc plated steel pin.
Brass blind threaded bush.
(*) Zinc plated steel blind threaded bush.

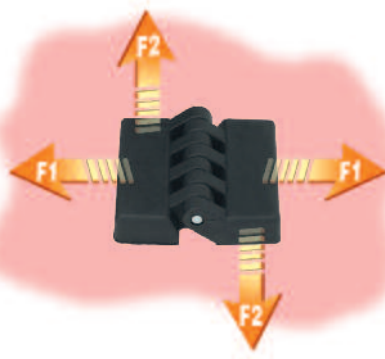

SPECIAL REQUESTS:

- None.

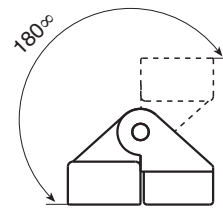
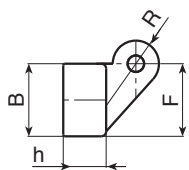
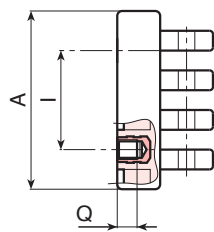
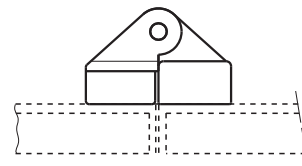
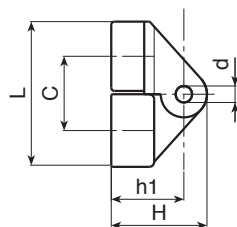
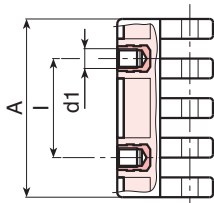

Art.	I	C	A	B	L	F	h	h1	H	d	R	d1	Q	Weight (gr)	F1 (N)	F2 (N)
O450-30	15	18	30	17	35	18	11	19	25	4	11	M5	8	26	1180	1130
O450-54	30	22	54	21	44	22	13	22	30	5	15	M6	7	58	1520	2980
O450-78	42	32	78	30	61	30	18	31	42	8	21	(*) M8	10	178	885	2875

ART. 0452

UNIVERSAL HINGE WITH THREADED INSERT FOR MOUNTING ON ANGULAR DOOR

MATERIAL:

Reinforced polyamide.
Oils and greases resistant.

SURFACE:

Satin.

COLOUR:

Black (RAL 9011).

INSERTS:

Zinc plated steel pin.
Brass blind threaded bush.
(*) Zinc plated steel blind threaded bush.

SPECIAL REQUESTS:

- None.

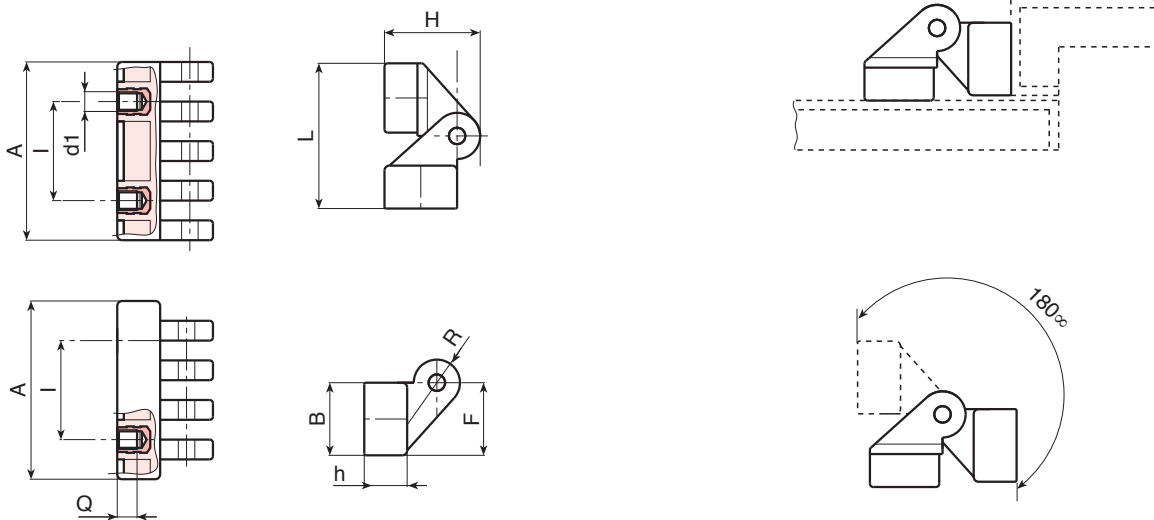
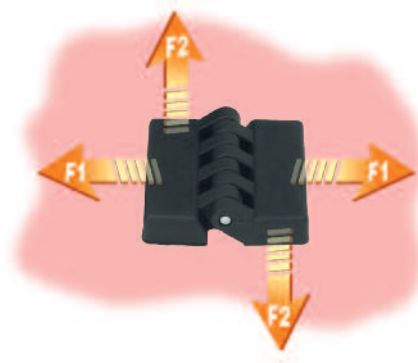

Art.	I	C	A	B	L	F	h	h1	H	d	R	d1	Q	Weight (gr)	F1 (N)	F2 (N)
O452-30	15	18	30	17	36	18	11	19	25	4	11	M5	8	26	1180	1130
O452-54	30	22	54	21	44	22	13	22	30	5	15	M6	7	58	1520	2980
O452-78	42	32	78	30	62	30	18	31	42	8	21	(*) M8	10	178	885	2875

ART. 0451

UNIVERSAL HINGE WITH THREADED STUD FOR MOUNTING ON STRAIGHT DOOR

MATERIAL:

Reinforced polyamide.
Oils and greases resistant.

SURFACE:

Satin.

COLOUR:

Black (RAL 9011).

INSERTS:

Zinc plated steel pin.
Zinc plated steel threaded stud.

SPECIAL REQUESTS:

- None.

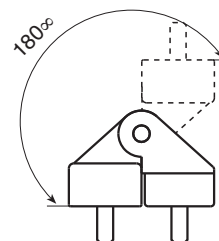
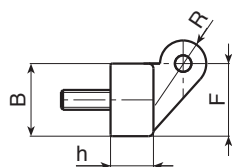
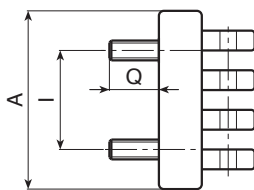
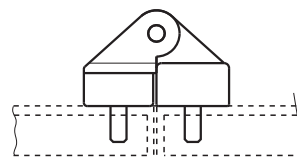
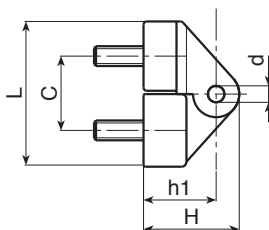
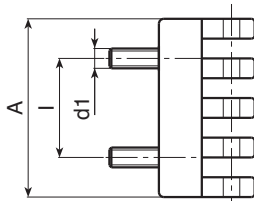
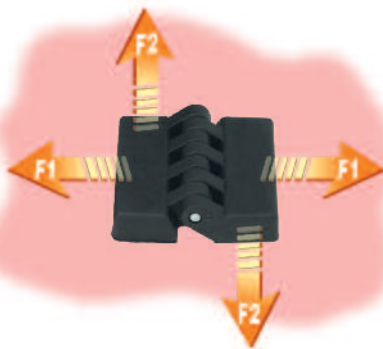

Art.	I	C	A	B	L	F	h	h1	H	d	R	d1	Q	Weight (gr)	F1 (N)	F2 (N)
O451-30	15	18	30	17	35	18	11	19	25	4	11	M5	10	38	690	1080
O451-54	30	22	54	21	44	22	13	22	30	5	15	M6	15	72	295	1670
O451-78	42	32	78	30	61	30	18	31	42	8	21	M8	20	190	1025	2830

ART. 0453

UNIVERSAL HINGE WITH THREADED STUD FOR MOUNTING ON ANGULAR DOOR

MATERIAL:

Reinforced polyamide.
Oils and greases resistant.

SURFACE:

Satin.

COLOUR:

Black (RAL 9011).

INSERTS:

Zinc plated steel pin.
Zinc plated steel threaded stud.

SPECIAL REQUESTS:

- None.

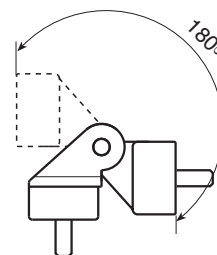
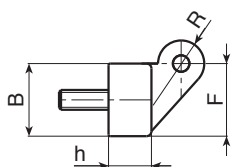
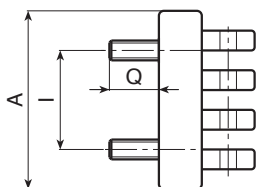
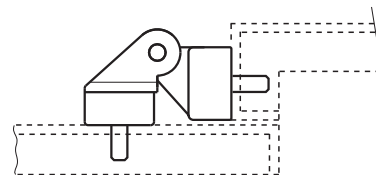
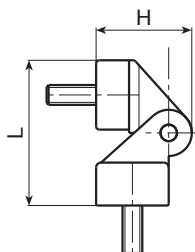
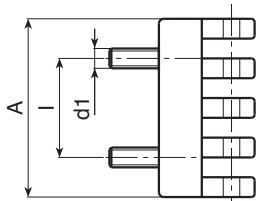
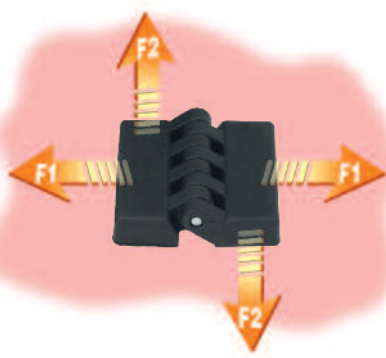
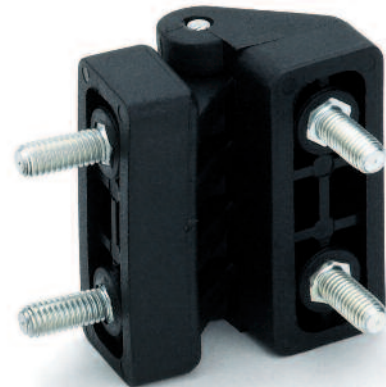















Art.	I	C	A	B	L	F	h	h1	H	d	R	d1	Q	Weight (gr)	F1 (N)	F2 (N)
O453-30	15	18	30	17	35	18	11	19	25	4	11	M5	10	38	690	1080
O453-54	30	22	54	21	44	22	13	22	30	5	15	M6	15	72	295	1670
O453-78	42	32	78	30	61	30	18	31	42	8	21	M8	20	190	1025	2830

0 – HINGES





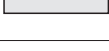











COLOUR CHART

R A L

COLOUR		RAL	CODE
Black		9011	01
Orange		2004	02
Orange		2011	03
White		9010	04
Blue		5002	05
Blue		5005	06
Blue		5015	07
Blue		5018	19
Blue		5019	21
Blue		5010	22
Yellow		1007	09
Yellow		1021	10
Grey		7024	12
Grey		7035	13
Red		3000	16
Green		6024	17

O T H E R C O L O U R S

COLOUR		REF.	CODE
White		-	52
Blue		-	53
Blue		pant. 645 U	54
Blue		pant. 300	55
Grey		-	57
Grey		-	59
Grey		NCS 7500	60
Red		-	64
Red		-	65
Natural		-	66
Green		-	70
Brown		-	71
Cream		-	72
Violet		-	73



WWW.ROLLMEX.FI

ROLLMEX Oy

Takojankatu 4 - 33540 TAMPERE
Push. 010-6661122 - Fax 03-3640072
tamper@rollmex.fi

Karjalankatu 21 - 15140 LAHTI
Push. 010-6661121 - Fax 03-7511026
lahti@rollmex.fi

AUTHORISED RESELLER